

# ORTHO PANTOMOGRAPH™ OP 3D™ LX

Imaging Innovation Expanded.



## Simplify, streamline, and expand your diagnostic capabilities

### The next generation of proven DEXIS cone beam technology.

Built on OP 3D technology, this multimodality imaging platform expands your 3D diagnostic capabilities with a wide range of clinical applications that support your evolving practice and enhance diagnostic confidence.

The 2D and 3D imaging options cover a wide range of dental extraoral needs, from endodontics to complex surgical cases. This next generation system offers flexible FOV\* options ranging from 5x5 up to 15x20 – the largest view option available on a DEXIS OP 3D platform to date. With short scan times, the OP 3D LX captures the maxillofacial complex and large diagnostic areas in one non-stitched scan for fast workflows.

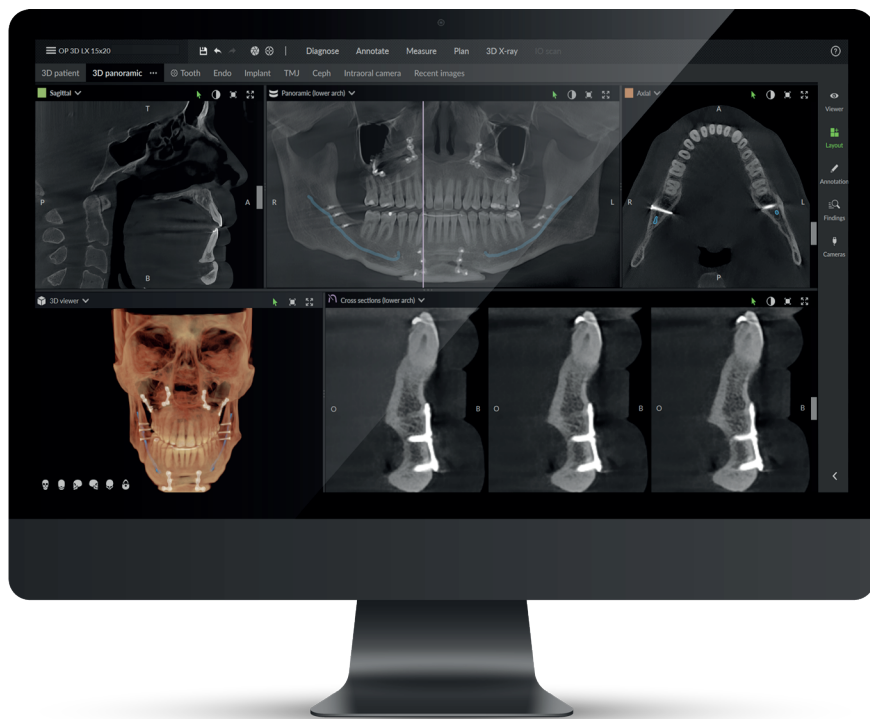

\*All FOV (field of view) displayed are height x diameter (in centimeters).  
This unit is FDA cleared.

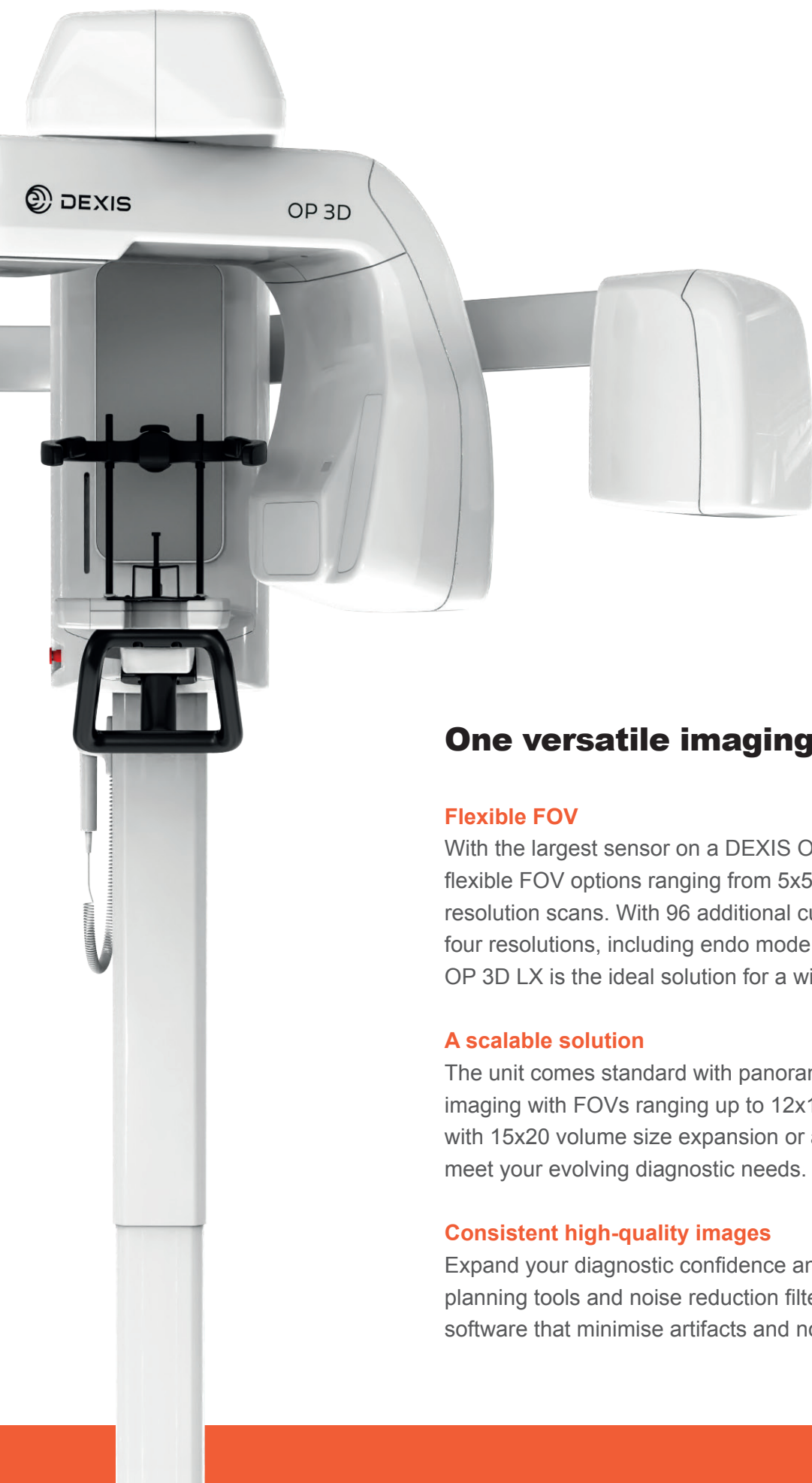

## One versatile imaging platform

### Flexible FOV

With the largest sensor on a DEXIS OP 3D platform, OP 3D LX offers flexible FOV options ranging from 5x5 up to 15x20 complete high-resolution scans. With 96 additional customizable FOV options and four resolutions, including endo mode and low dose mode, the OP 3D LX is the ideal solution for a wide range of dental demands.







### A scalable solution

The unit comes standard with panoramic, extraoral bitewing and 3D imaging with FOVs ranging up to 12x15. Easily upgrade your system with 15x20 volume size expansion or add cephalometric modality to meet your evolving diagnostic needs.

### Consistent high-quality images

Expand your diagnostic confidence and capabilities with the implant planning tools and noise reduction filters embedded into the system software that minimise artifacts and noise.

## Explore the view options available

FOV size (HxD)	Clinical application
<p>5x5</p> 	<p><b>Localised diagnostics</b> Endodontic evaluation, single implant sites, and pathoses</p>
<p>6x9</p> 	<p><b>Single arch</b> Implant planning, surgical guide creation, and impacted canines</p>
<p>8x8</p> 	<p><b>Compact dual arch</b> Mandibular and maxillary treatment planning of dental implants in both arches</p>
<p>10x10</p> 	<p><b>Complete dentition</b> Mandible and maxilla with 3rd molar region, and lower maxillary sinuses — ideal for multiple implants or periodontal evaluation</p>
<p>12x15</p> 	<p><b>Entire dentition</b> Mandible and maxilla, bilateral TMJ, sinus, and pharyngeal airway</p>
<p>15x20*</p> 	<p><b>Maxillofacial complex</b> Mandible and maxilla, bilateral TMJ, upper and lower airway, soft tissue profile, OMS, and orthodontic analysis</p>

FOV options can be adjusted to offer 96 unique sizes.

Sizes may not be available in all regions.

\*Optional field of view.

## Intuitive and interactive features

The feature enhancements designed in the OP 3D LX elevate your diagnostic confidence with every scan.



### User interface

OP 3D LX offers an intuitive user interface that enables you to easily position the patient, visually choose the areas of interest with your 3D, panoramic, or cephalometric settings and preview the X-ray image shortly after exposure without opening any image viewing software.

### Stitch-free scans

You can accurately diagnose, plan, and treat your patients with confidence using single pass capture with no stitching on every scan size.

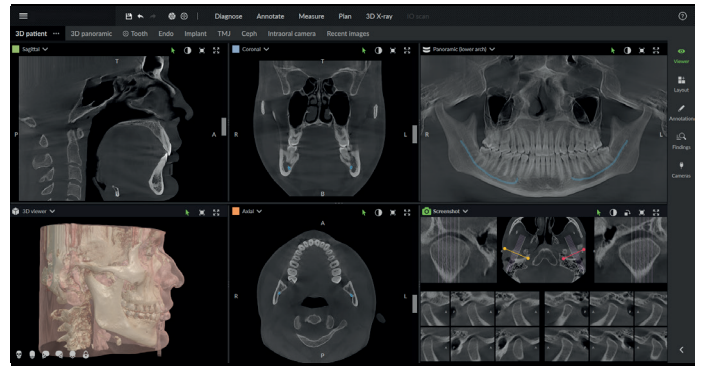

### Re-engineered head support

The new head support design provides options to scan the patient without interfering with the patient's soft tissue profile optimised for orthodontic and surgical applications.



## Enhanced smart features

### Intuitive accuracy

The intuitive user interface in OP 3D LX system makes it easy to select your field of view and allows for accurate anatomy visualisation, vertical adjustments, and bi-directional scout modifications so that the clinical staff can capture only the structures of interest.

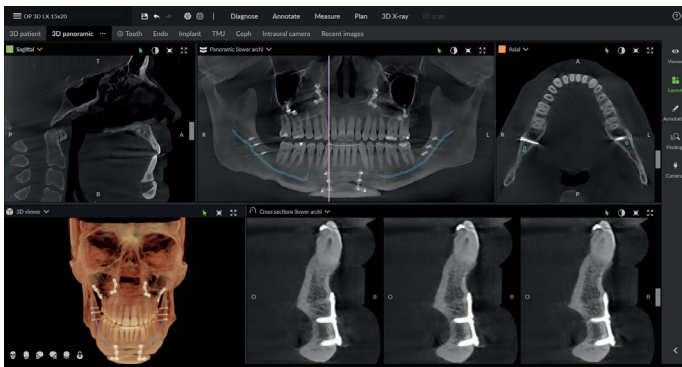
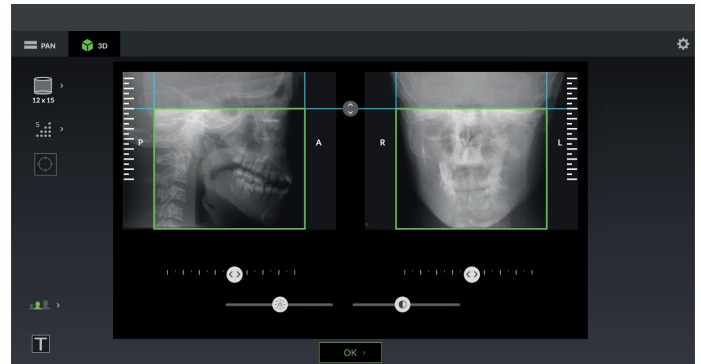

### Enhanced visibility

Enjoy the next generation of automated ICE\* (Implant Contrast Enhancer) and MAR (Metal Artifact Reduction) to provide greater visibility of internal metal structures of existing implants, while minimising the impact of metal and restorations, all leading to improved diagnostic confidence.

### Cloud-based service connectivity

This OP 3D LX feature simplifies service and maintenance for improved practice productivity and uptime.



\*Product feature not available until 2024.



## Assisted intelligence (AI) for workflow efficiencies

Our intuitive AI-assisted software features, in the award-winning DTX Studio™ Clinic, support a more efficient workflow allowing you to spend less time in the software and more time with your patient.

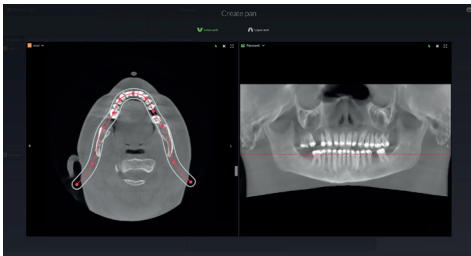

Automatic focal trough

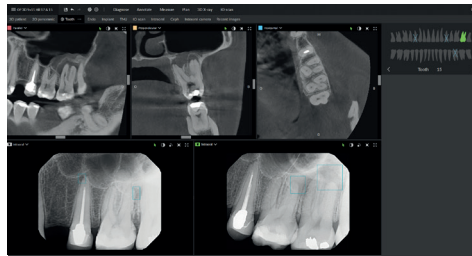

Tooth-centric navigation workflow

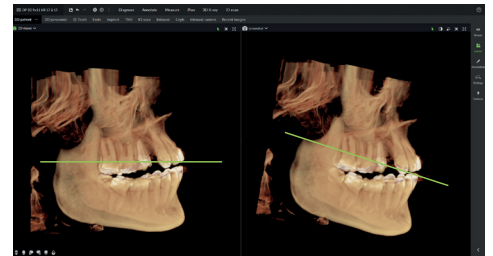

Patient positioning correction

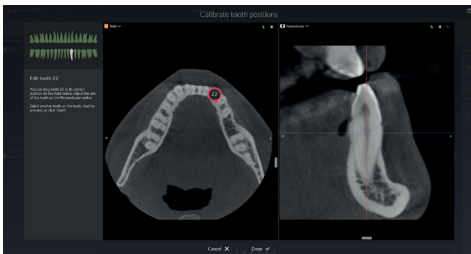

Auto 3D tooth positioning

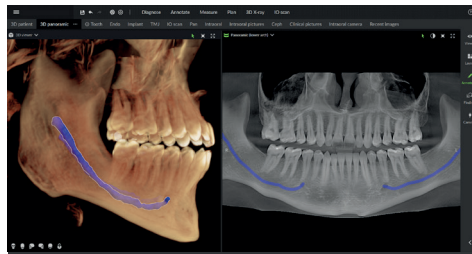

Mandibular nerve canal annotation

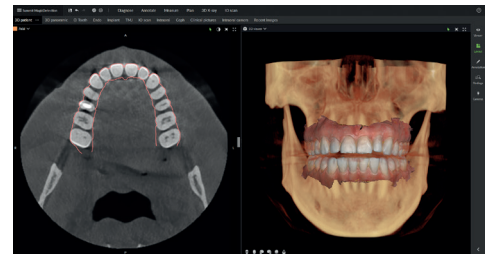

Merge CBCT and intraoral scans

### SmartFocus

Automated tooth-by-tooth navigation saves you significant time and effort. Using tooth positions as your reference, SmartFocus™ lets you browse across various patient images from different devices and sessions with just one click.



# Discover the possibilities with 3D imaging

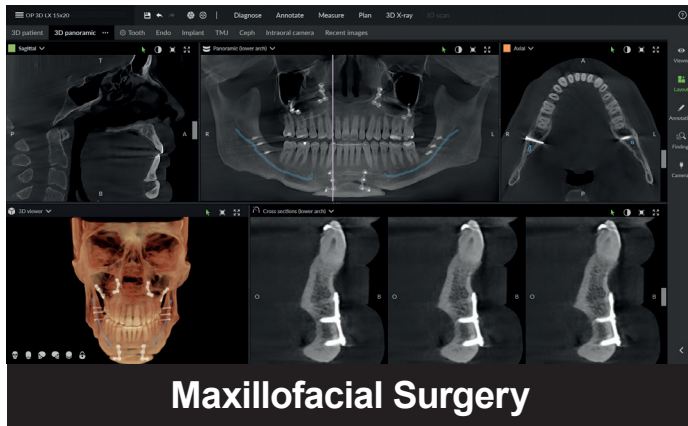

With clear and accurate data during a pre-operative evaluation, maxillofacial surgeons can assess and plan third molar extractions, determine bone dimension and quality, assess anatomical structures like the maxillary sinus, and plan surgical exposures.

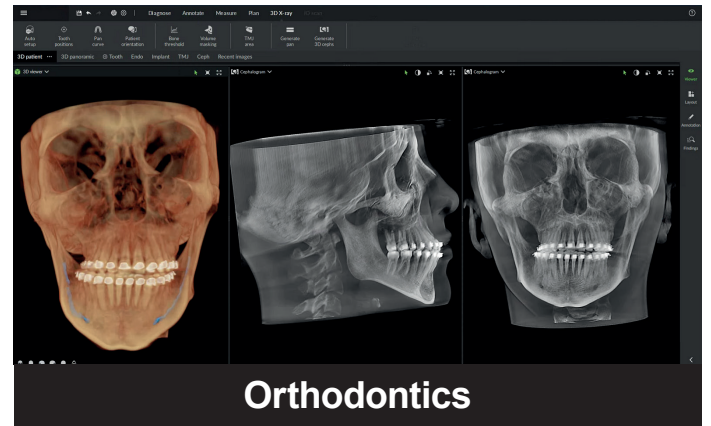

Elevate your clinical confidence with high-resolution CBCT imaging for orthodontic treatment evaluation. Offering a powerful solution for positioning impacted maxillary canines and supernumeraries, diagnosing root resorption, unerupted teeth, severe skeletal discrepancies, and other difficult cases.

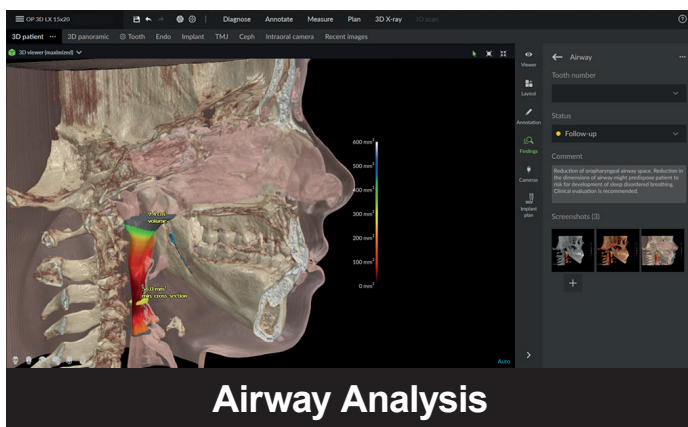

With its 15x20 large field of view scan, the OP 3D LX can support the evaluation of both the upper and lower airway in one quick scan. This scan includes the nasal cavity, nasopharynx, oropharynx, and hypopharynx in your choice of resolutions. This can help with patient-specific treatment options for airway disorders such as mandibular advancement devices, orthodontic expansion, or orthognathic surgery.

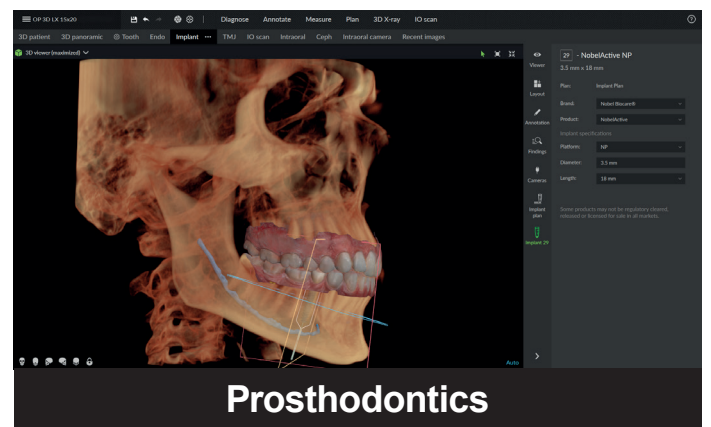

Capture high-resolution 3D scans to support diagnostic clarity for treatment planning, surgical, and prosthodontic applications of implant dentistry. Our workflows support ultimate visualisation by allowing practitioners to merge 3D data with intraoral surface scans for a complete visualisation of the patient anatomy.



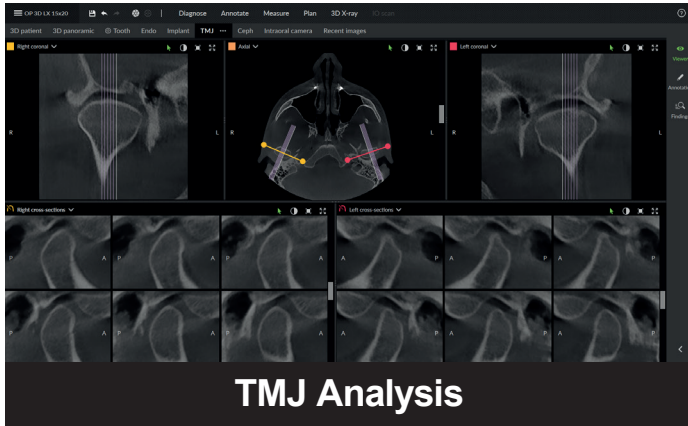

**TMJ Analysis**

Ensure proper joint positioning prior to orthodontic planning and evaluate condylar and occlusal changes. The OP 3D LX bilateral visualisation of the temporomandibular joint to assess the position within the fossa, degenerative changes to the hard tissue, and to assess the vertical dimension on larger prosthetic cases.

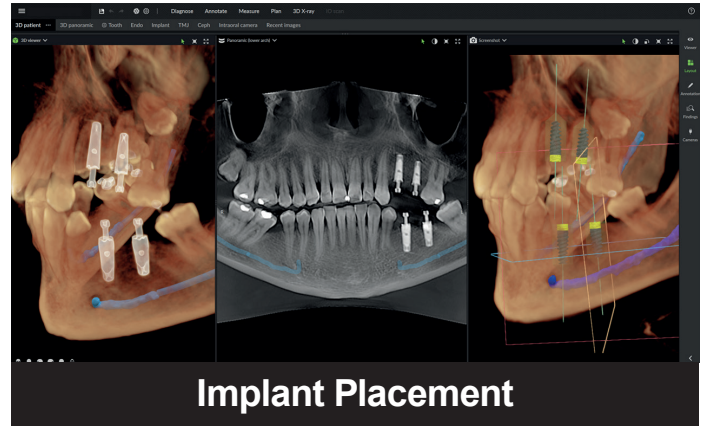

**Implant Placement**

Whether you're planning single unit implants, All-on-4®, or zygomatic implants, the OP 3D LX allows you to expand your clinical applications, allowing for multidimensional imaging, presurgical assessments of anatomy; and supporting more accurate and precise implant placements.

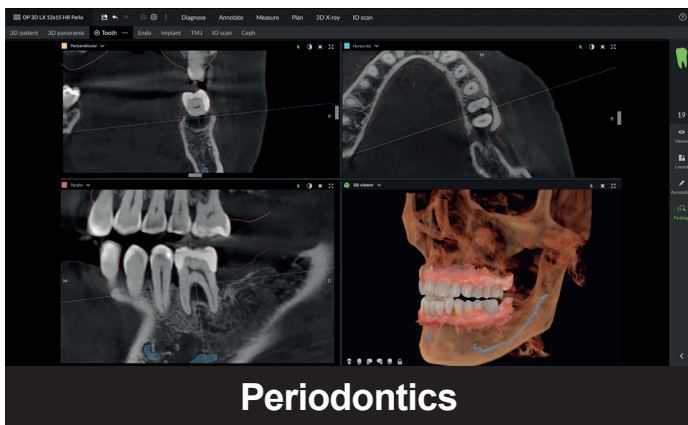

**Periodontics**

From implant placement to surgical options for the management of bone loss, the OP 3D LX flexible field of view options allow you to perform a thorough analysis of bone structure as well as sinus and nerve location.

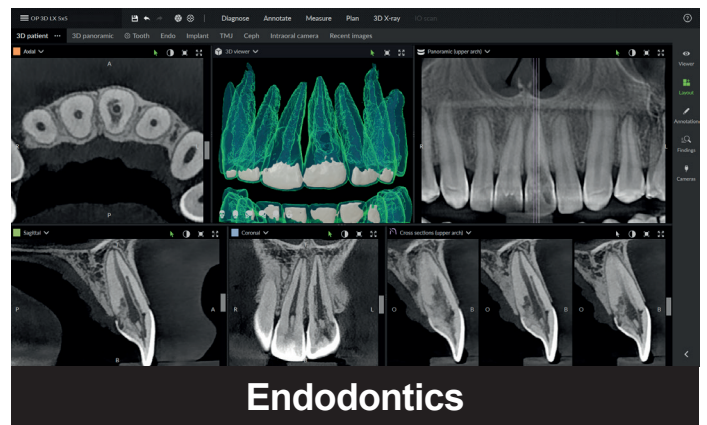

**Endodontics**

With its dedicated endo resolution and precise scan positioning that can easily be centered on an individual tooth, the OP 3D LX has been optimised to help visualise the small details which can be critical to endodontic diagnosis and planning.



**DEXIS**

OP 3D

LX

# Technical specifications

Focal Spot	0.5 (IEC 60336/2020)
Tube Voltage	60 – 95 kV
Tube Current	2 – 16 mA
HU Capacity	35 kJ, 49 000 HU
Minimum Total Filtration	3.4 mm Al @ 95 kV
Wheelchair Accessible	Yes

2D	Panoramic	Cephalometric
Image Detector	IGZO TFT	IGZO TFT
Sensor Pixel Size	99 µm	99 µm
Image Pixel Size	95 µm	95 µm
Scan/Exposure Time	1.4 – 9.0 s	6.9 – 11.3 s
Image Field Height	128.4 – 187.0 mm	180.0 – 235.9 mm
Imaging Programs	Standard, segmented standard, pediatric, segmented pediatric, bitewing, Lateral TMJ	Lateral, pediatric lateral, PA, carpus
Weight	120 kg / 265 lbs	155 kg / 342 lbs

3D	CBCT
Image Detector	IGZO TFT
Image Voxel Size	80 – 400 µm
Scan Time	8 – 30 s
Exposure Time	0.9 – 19.4 s
Image Volume Sizes (HxD)	50x50, 60x90, 80x80, 100x100, 120x150, 150x200 mm
DICOM Support	Yes
Min. Room Height	2100 – 2455 mm

## Minimum System Requirements for 3D Acquisition Workstation

CPU (Processor)	Intel Core i5, i7 or Xeon, 4-cores or more
GPU (Graphics Processing Unit)	NVIDIA Quadro T1000 8GB NVIDIA GeForce RTX 3050 8GB
RAM (Memory)	16 GB or more
Storage (Hard Disk)	1 TB or more
Network	Gigabit Ethernet 1000 Mbs/s
Operating System	Windows 11 Pro or Enterprise 64-bit Windows 10 Pro or Enterprise 64-bit
Display	1920 x 1080 (Full HD) resolution or higher
Other	OpenCL 1.1 support DVD-ROM drive Anti-virus software
Notes	Please refer to software and device installation manuals for detailed requirements.

# Unit dimensions

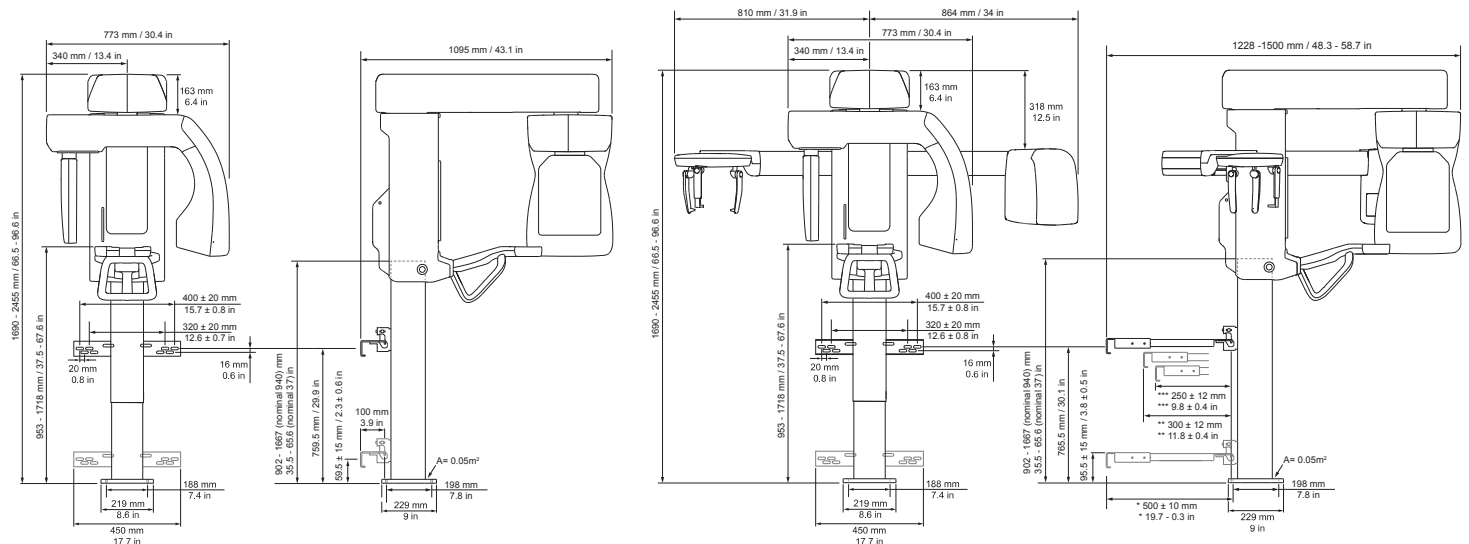

**Note:** Unit dimensions shown reflect the OP 3D LX. Illustrations reflect the current OP 3D platform.

# Continuing the DEXIS legacy of imaging innovation.

DEXIS has brought together some of the most recognised CBCT brands in the industry, including Instrumentarium, SOREDEX™, Cranex, Gendex™ and the well-known i-CAT™. With over 16,000 successful installations in the last 15 years, DEXIS OP 3D solutions lead the industry in reliable performance and innovation. DEXIS continues to back our state-of-the-art technology with a commitment to excellence and a dedication to customer satisfaction that make us the trusted choice for imaging needs around the world.

## About DEXIS

DEXIS is a global leading brand in digital radiography for 70+ years. Today, DEXIS has brought together the most trusted brands in 3D imaging, intraoral scanning solutions, and diagnostic software to provide you with a complete digital diagnostic solution. Our innovative award-winning technology enhances the way you diagnose, accelerates your workflow, and delivers simpler treatment paths with better patient outcomes.

### Clinical images courtesy of:

Dr. Katya Archambault, La Jolla, CA; Dr. Rebekah Browder, Westport, CT; Dr. Greg Gillespie, Vancouver, WA; Dr. Miguel Gonçalves, Portugal; Dr. Heidi Helin, Turku, Finland; Dr. Joe Mehranfar, Phoenix, AZ; Dental Scan Ltd, Manchester, UK; Dr. Michael Sohl, Stuart, FL; Dr. Kevin Wilke, Green Bay, WI; Dr. Lauri Vahtra, Tallinn, Estonia

The products, equipment and services illustrated and described in this brochure reflect knowledge at the time of printing. Full or partial reprinting is only permitted with permission from Dental Imaging Technologies Corporation. For more information, please visit: [DEXIS.com](http://DEXIS.com).

Dental Imaging Technologies Corporation reserves the right to make changes to specifications and features shown herein, or to discontinue the product described at any time without notice or obligation. Contact your local authorized representative for the most current information.

© 2023 Dental Imaging Technologies Corporation. ORTHOPANTOMOGRAPH™ OP 3D™ LX is a trademark of PaloDEX Group Oy. DTX Studio™ Clinic is a trademark of Nobel Biocare. All Rights Reserved. DX00929/RevC